

CUSTOMER: \_\_\_\_\_

DATE: \_\_\_\_\_

# APPROVAL SPECIFICATION



PRODUCT NAME: SMD power inductor

YOUR PART NO.:

OUR PART NO.: AMPIT5030-1 Series

VERSION: V1.0

<b>RECEPTION</b> <b>THE SPECIFICATION HAS BEEN ACCEPTED.</b>		
<b>DATE:</b>		
<b>COMPANY:</b>		
<b>CFMD</b>	<b>CHKD</b>	<b>RCVD</b>

MANUFACTURING NAME

SHENZHEN MICROGATE TECHNOLOGY CO. , LTD  
 Address: Microgate Smart Park, Technology Road,  
 Zhukeng Community, Longtian Street, Pingshan  
 District, Shenzhen.  
 Postcode: 518122  
 TEL: 86-755-28085000  
 FAX: 86-755-28085605

CFMD.	CHKD.	DSGD.
Remo	Hongpei Ding	Wei Liu

CATALOG

	<b>Component SPEC Version Record.....</b>	<b>3</b>
<b>1</b>	<b>Scope.....</b>	<b>4</b>
<b>2</b>	<b>Product Identification.....</b>	<b>4</b>
<b>3</b>	<b>Appearance, Dimensions and Material.....</b>	<b>4</b>
<b>4</b>	<b>Testing Conditions.....</b>	<b>5</b>
<b>5</b>	<b>Electrical Characteristics.....</b>	<b>5</b>
<b>6</b>	<b>Reliability.....</b>	<b>6-8</b>
<b>7</b>	<b>Recommended Soldering Condition.....</b>	<b>9</b>
<b>8</b>	<b>Packaging.....</b>	<b>10</b>
<b>9</b>	<b>Products Storage.....</b>	<b>11</b>

### Component SPEC Version Record

Rev.	Effective Date	Changed Contents	Change Reasons	Approved By
V1.0	2022.4.18	New released	/	Remo

Confidential for Microgate

## 1. Scope

This specification applies to the AMPIT5030 series of SMD Power inductors.

## 2. Product Identification

AMPIT   5030   -   1   -   3R3   N   10   -   LF  
 ①            ②            ③            ④            ⑤            ⑥            ⑦

- ① Product Symbol (Automotive electronics products)
- ② Product dimensions
- ③ Winding number: (1: One windings)
- ④ Inductance Value: (3R3: 3.3uH; 220:22uH; 331:330uH)
- ⑤ Inductance Tolerance: (M: ±20% ; N: ±30%)
- ⑥ Process code
- ⑦ Lead free product.

## 3. Appearance, Dimensions and Material

### 3.1 Appearance and dimensions

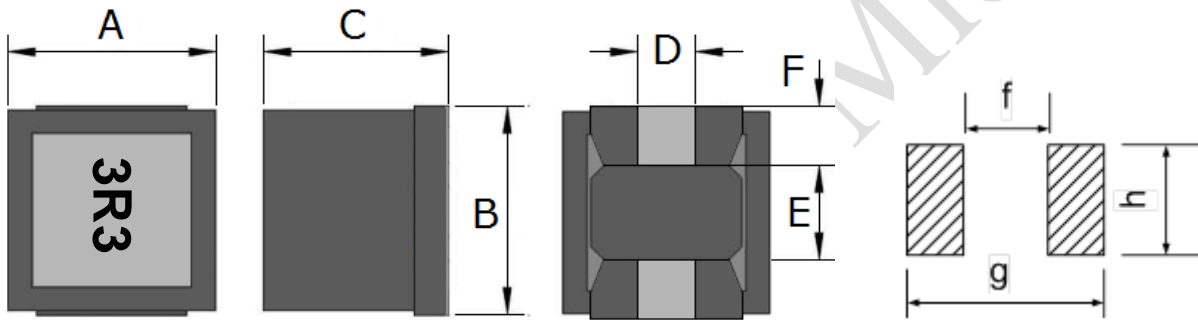

Recommended Land Pattern

Dimensions in mm								
A	B	C	D	E	F	f	g	h
5.0±0.3	5.3±0.3	3.0 Max.	1.8 Typ.	2.1 Typ.	1.6 Typ.	1.9 Typ.	5.7 Typ.	2.2Typ.

### 3.2 Electrical Schematic

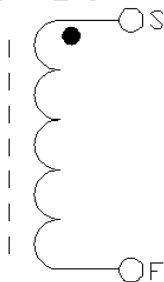

#### 4. Testing Conditions

Unless otherwise specified, the standard conditions for measurement/test as:

Ambient Temperature : 5 to 35°C  
 Relative Humidity: 25 to 85% RH  
 Atmospheric Pressure: 86 to 106 kPa

If any doubt on the results, measurements/tests should be made within the following limits:

Ambient Temperature : 25±1°C  
 Relative Humidity: 60 to 70% RH  
 Atmospheric Pressure: 86 to 106 kPa

#### 5. Electrical Characteristics And Test Instruments

Microgate Part No.	Inductance L (uH) 100KHz/1V	DCR (Ω)	Isat <sup>1</sup> (A)	Irms <sup>2</sup> (A)
		Max.	Typ.	Typ.
AMPIT5030-1-3R3N10-LF	3.3±30%	0.040	3.60	2.60
AMPIT5030-1-331M10-LF	330±20%	3.400	0.39	0.20
AMPIT5030-1-101M-LF	100 ±20%	1.056	0.56	0.40

#### Test instruments and remarks

- \* All test data is referenced to 25°C ambient.
- \* L test by CHROMA 3302 meter or equivalent.
- \* DCR test by Tonghui TH2516B meter or equivalent.
- \* CHROMA 3302 and 1320 meter for IDC.
- \* Isat: DC current (A) that will cause L0 to drop approximately 30%.
- \* Irms: DC current (A) that will cause an temperature rise ΔT approximate to 40°C.
- \* The rated current as listed is either the saturation current or the heating current depending on which value is lower.
- \* Operating temperature: -50°C to +150°C (Including self-heating)
- \* The part temperature (ambient + temp rise) should not exceed 150°C under worse case operating conditions. Circuit design, component placement, PCB trace size and thickness, airflow and other cooling provision all affect the part temperature. Part temperature should be verified in the end application.

6. Reliability

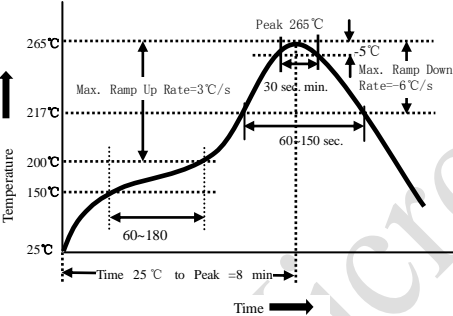
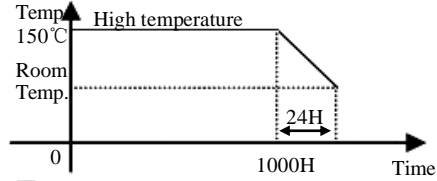
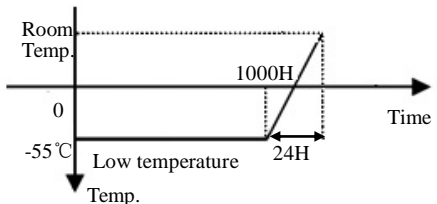
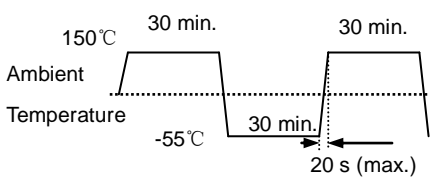
No.	Item	Requirements	Test Methods and Remarks	Reference	Sample Size
1	Solderability	(1) Terminal area shall be at least 95% covered.	①Temperature: $240 \pm 5^\circ\text{C}$ , flux 5-10 s. ②Sample immersion tin furnace $3 \pm 1\text{s}$ . ③Sn/3.0Ag/0.5Cu	AEC-Q200 (J-STD-002)	15
2	Resistance to Soldering Heat	(1) No case deformation or change in appearance. (2) $ \Delta L_0/L_0  \leq 10\%$	①The peak temperature: $260+5/-0^\circ\text{C}$ . ②Reflow: 3times. ③Temperature curve is as below: 	AEC-Q200 (MIL-STD-202 Method 210)	30
3	High Temperature Storage	(1) No case deformation or change in appearance. (2) $ \Delta L_0/L_0  \leq 10\%$	①Temperature: $150 \pm 2^\circ\text{C}$ . ②Time : 1000(+48,0) hours. ③Measurement at $24 \pm 4$ hours after test conclusion. 	AEC-Q200 (MIL-STD-202 Method 108)	77
4	Low Temperature Storage	(1) No case deformation or change in appearance. (2) $ \Delta L_0/L_0  \leq 10\%$	①Temperature: $-55 \pm 2^\circ\text{C}$ . ②Time : 1000(+48,0) hours. ③Measurement at $24 \pm 4$ hours after test conclusion. 		
5	Temperature Cycling	(1) No case deformation or change in appearance. (2) $ \Delta L_0/L_0  \leq 10\%$	①First $-55^\circ\text{C}$ for 30 minutes, last $150^\circ\text{C}$ 30minutes as 1 cycle. Go through 1000 cycles.. ②Max transfer time is 20 second. ③Measurement at $24 \pm 4$ hours after test conclusion. 	AEC-Q200 (JESD22-A104)	77

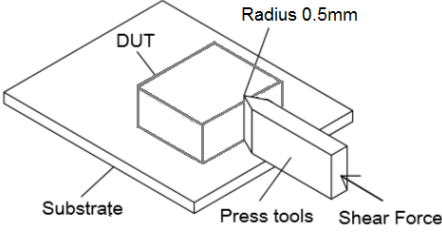
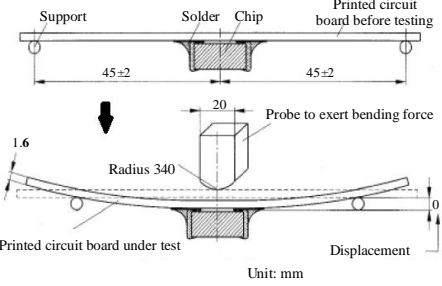
No.	Item	Requirements	Test Methods and Remarks	Reference	Sample Size
6	Resistance to Solvents	(1) No case deformation or change in appearance. (2) $ \Delta L_0/L_0  \leq 10\%$	①Prepare solvent (isopropyl alcohol: kerosene: ethylbenzene =4:9:3 volume ) ②Specimen be completely immersed in solvent for 3+0.5/-0min ③Brush dipped in solution until wetted and brush part 10 strokes . ④Repeat 2 more times, Air blow dry. ⑤Inspect at 3x magnifier for marking and 10x for part damage. Note: Add Aqueous wash chemical. OKEM Clean or equivalent. Do not use banned solvents.	AEC-Q200 (MIL-STD-202 Method 215)	15
7	ESD	(1) No case deformation or change in appearance. (2) $ \Delta L_0/L_0  \leq 10\%$	①HBM ESD discharge waveform,8KV	AEC-Q200 (AEC-Q200-002)	15
8	Biased Humidity	(1) No case deformation or change in appearance. (2) $ \Delta L_0/L_0  \leq 10\%$	①1000(+48,0) hours, 85 °C/85% RH. ②Unpowered. ③Measurement at 24±4 hours after test conclusion.	AEC-Q200 (MIL-STD -202 Method 103)	77
9	Terminal Strength	(1) No case deformation or change in appearance. (2) $ \Delta L_0/L_0  \leq 10\%$	①The test samples shall be soldered to the board. ②17.64N, 60±1s 	AEC-Q200 (AEC-Q200-006)	30
10	Board Flex	(1) No case deformation or change in appearance. (2) $ \Delta L_0/L_0  \leq 10\%$	①Part mounted on a 100mm*40mm FR4 PCB board, which is 1.6±0.2 mm thick and as a Layer-thickness 35 μm ± 10 μm. ②Bending speed is 1mm/s. ③Keeping the P.C Board 2 mm minimum for 60 seconds. 	AEC-Q200 (AEC-Q200-005)	30

No.	Item	Requirements	Test Methods and Remarks	Reference	Sample Size
11	Vibration	(1) No case deformation or change in appearance. (2) $ \Delta L0/L0  \leq 10\%$	①Frequency range : 10~2000Hz. ②Amplitude: 1.5mm ,5g. ③Sweep time and duration: 10~2000~10Hz for 20 minutes. ④Each four hours(12 times) in X,Y,Z direction, 12 hours in total.	AEC-Q200 (MIL-STD-202 Method 204)	30
12	Mechanical Shock	(1) No case deformation or change in appearance. (2) $ \Delta L0/L0  \leq 10\%$	Half sine shock pulse,100g,6ms,6 shocks in each 3 mutually perpendicular directions (total of 18 shocks)	AEC-Q200 (MIL-STD-202 Method 213)	30
13	Loading at High Temperature	(1) No case deformation or change in appearance. (2) $ \Delta L0/L0  \leq 10\%$	①Temperature: 150±2℃. ②Time : 1000 (+48,0) hours. ③Applied Current : Rated current. ④Measurement at 24±4 hours after test conclusion.	AEC-Q200 (MIL-PRF-27)	77
14	Loading at Damp Heat	(1) No case deformation or change in appearance. (2) $ \Delta L0/L0  \leq 10\%$	①Temperature: 60±2℃, Humidity: 90% to 95% RH. ②Time : 1000 (+48,0) hours. ③Applied Current : Rated current. ④Measurement at 24±4 hours after test conclusion.	AEC-Q200	77
15	Drop	(1) No case deformation or change in appearance. (2) $ \Delta L0/L0  \leq 10\%$	①Height: 1 m, Free fall, 10times. ②Direction: 1 Angle, 1side, 2surface.	AEC-Q200	30
16	Flammability (External Flame)	(1) No case deformation or change in appearance. (2) $ \Delta L0/L0  \leq 10\%$	Method111/UL94	AEC-Q200	15
17	Random Vibration	(1) No case deformation or change in appearance. (2) $ \Delta L0/L0  \leq 10\%$	Three Times reflow pretreatment (reflow TMAX265 + 5 -0) vibration plate: “8 x 5” Printed Circuit Board, 0.031” thick, with 7 fixed points on the long side and 2 fixed points on the opposite side of the corner	AEC-Q200 (JESD22-B100)	30
18	Electrical Characterization	According to specification	Parametrically test per lot and sample size requirements, summary to show Min, Max, Mean and Standard deviation at room as well as Min and Max operating temperatures.	AEC-Q200 (User Spec.)	77

\*All above experiments items need 3 Lot., sample size is as specified in the table above.

\*Sample size standard is from AEC-Q200 : qualification sample size requirements.



## 7. Recommended Soldering Conditions

### (1) Reflow soldering conditions

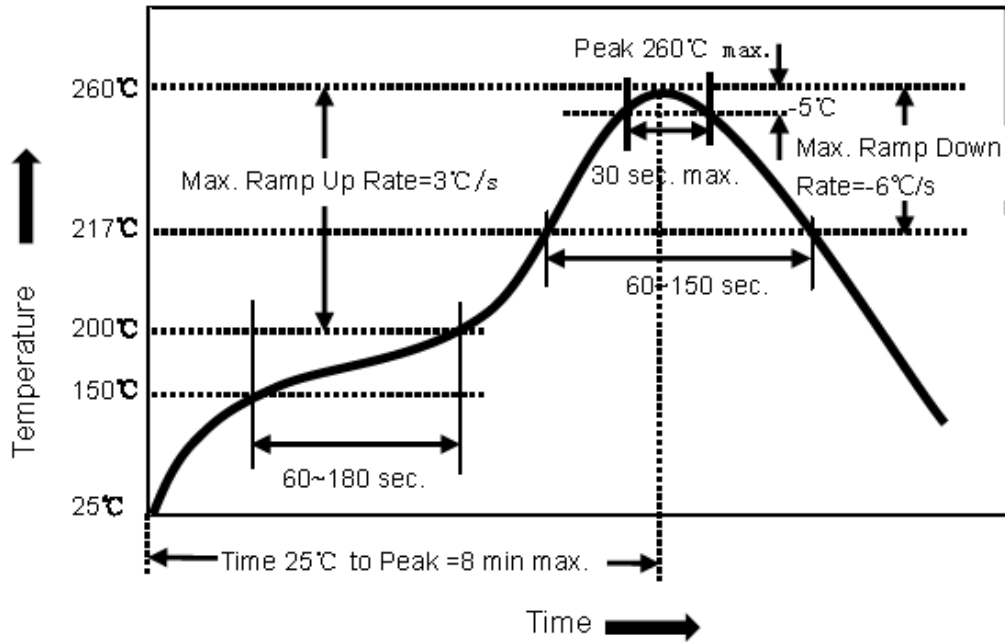

\*Above reflow soldering curve is from J-STD-020D.

### (2) Iron soldering

The following conditions must be strictly followed when using a soldering iron.

Pre-heating	150°C 1 minute
Tip temperature	350°C max
Soldering iron output	30w max
End of soldering iron	φ 1mm max
Soldering time	3 seconds max

## 8.Packaging

### (1) Dimension of tape (Unit: mm)

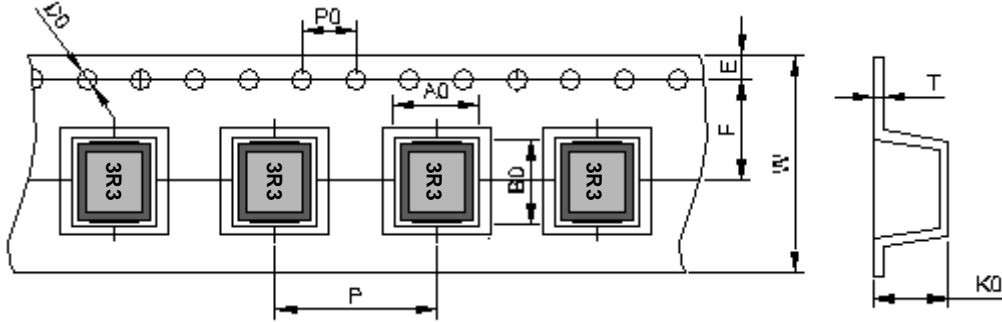

W	A0	B0	K0	E	F	P	P0	D0	T
12.0±0.3	5.3±0.1	5.6±0.1	3.3±0.1	1.75±0.1	5.5±0.1	8±0.1	4.0±0.1	1.5+0.1/-0.0	0.40±0.1

### (2) Dimension of reel (Unit: mm)

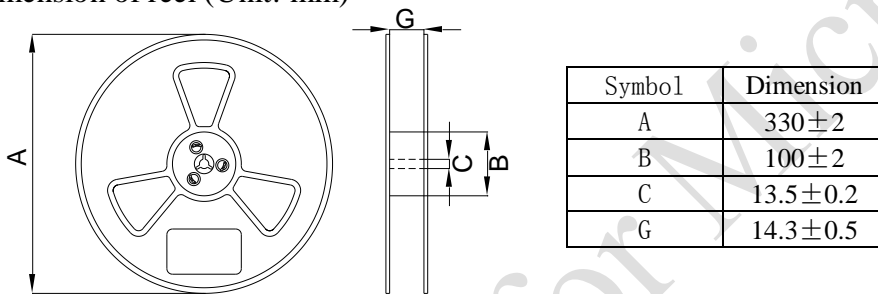

### (3) Taping figure and drawing direction

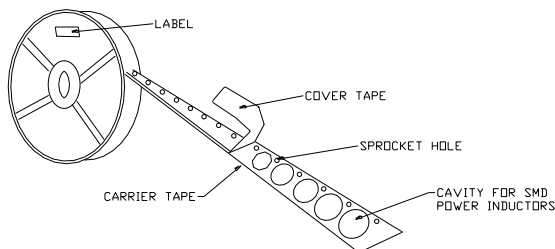

### (4) Packaging quantities: 2000PCS/Reel.

### (5) Peeling strength of cover tape:

The peel force of top cover tape shall be between 0.10N to 1.3N

\*the peel force standard is from EIA-481-D

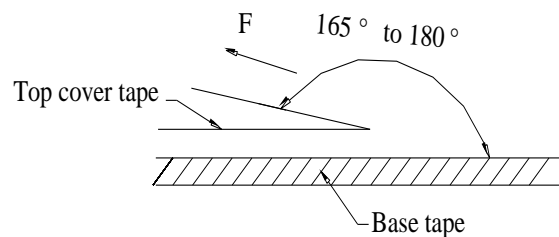

Room Temp. (°C)	Room Humidity (%)	Room aim (hpa)	Peel Speed mm/min
5-35	45-85	860-1060	300

SHENZHEN MICROGATE TECHNOLOGY CO., LTD.

Add: Microgate Smart Park, Technology Road, Zhukeng Community, Longtian Street, Pingshan District, Shenzhen.

Tel: +86-755-28085000

Fax: +86-755-28085605

## 9. Products Storage

### (1) Storage period

Products which inspected in MICROGATE over 12 months ago should be examined and used, which can be confirmed with inspection No. marked on the container. Solderability should be checked if this period is exceeded.

### (2) Storage conditions

Products should be storage in the warehouse on the following conditions:

Temperature: -10 ~+ 35°C

Humidity: Less than 70% relative and humidity

No rapid change on temperature and humidity.

### (3) Don't keep products in corrosive gases such as sulfur, chlorine gas or acid, or it may cause oxidization of electrode, resulting in poor solderability.

### (4) Products should be storage on the palette for the prevention of the influence from humidity, dust and so on.

### (5) Products should be storage in the warehouse without heat shock, vibration, direct sunlight and so on.

### (6) Products should be storage under the airtight packaged condition.